

Panasonic
ideas for life

BT-LH910G
LCD Video Monitor





Best-in-class*¹ WXGA Resolution, High Contrast with the New IPS LCD Panel. Together with New Functions, such as 3D Shooting Assist*².

The BT-LH910G is a portable, high-resolution LCD video monitor with advanced broadcasting functions. Its newly developed 23 cm (9 inches) New IPS LCD panel boasts the best-in-class*¹ WXGA (1280 x 768) resolution, high brightness and superb contrast, for use in applications that far exceed those of conventional compact monitors. The BT-LH910G also offers extensive display functions, like a RGB WFM, a color audio level meter and Focus Assist, to respond to diverse production and broadcasting needs. Using two SDI input terminals, the BT-LH910G can overlay the left-eye and right-eye images of a 3D source. Plus, it's equipped with a variety of 3D Shooting Assist*² functions. From outdoor and studio recording to OB van installation and sub-monitor use for live broadcasting, the BT-LH910G meets high-end production and broadcasting needs.

*1: In the 23 cm (9 inches) and smaller professional monitor category (according to a Panasonic survey, as of March 2011). *2: These functions assist 3D shooting with a 2D image display. The BT-LH910G does not display 3D images.

The 23 cm (9 inches) New IPS LCD Panel Produces High-Resolution, High-Quality Images.

WXGA (1280 x 768), the Highest Resolution in the Portable Monitor Class

The New IPS LCD panel features a new pixel structure that heightens resolution more than 20% in terms of area ratio as compared with our previous model BT-LH900A. This 23 cm (9 inches) LCD panel has 1280 x 768 pixels, which rivals the number of pixels in our 43 cm (17 inches) BT-LH1710 LCD monitor. The BT-LH910G offers the highest level of resolution in the portable monitor class, and opens the door to new applications in HD recording, production and broadcasting by surpassing the limits of conventional small monitors.

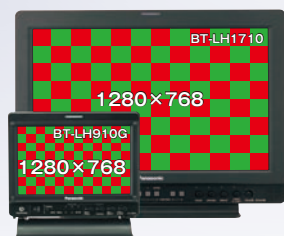

High Brightness, Superb Contrast, Wide Viewing Angle

The new pixel structure incorporated in the New IPS LCD panel has dramatically improved the light transmittance of the LCD panel, for greater brightness. New liquid crystal materials and newly designed color filters have also achieved high contrast to render crisp, clear images. Together, they provide easy-to-see images even for outdoor viewing. The wide viewing angle of 176° in both vertical and horizontal directions is the best among LCD displays available today. The New IPS LCD panel boasts superb color display characteristics with minimal changes in brightness or color even when viewed at an angle.

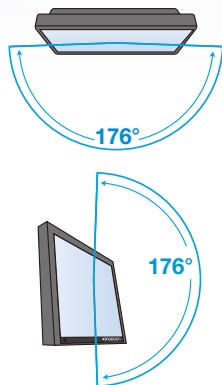

LED Backlight

The New IPS LCD panel features an LED backlight. Developed with advanced technology, this mercury-free panel also helps to preserve the global environment.

High-performance Image Processing Engine for Superb Moving Image Quality

- Precise 10 bit image processing uses a three-dimensional LUT (Look Up Table) for each RGB color to achieve faithful color reproduction from low to high brightness levels.
- The diagonal line compensation circuit minimizes jagged noise on diagonal lines.
- The high-speed, high-performance I/P conversion circuit achieves superb motion response with a delay of less than one field between input and panel display.
- Improved response time in intermediate gradations provides vivid and clear image displays without blurring.

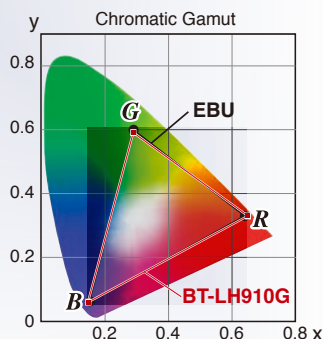

Gradation and RGB Manual Adjustment

In order to match the LCD monitor to professional broadcasting applications, compensation is conducted for each monitor in 256 discrete RGB steps, and rated gamma properties ($\gamma = 2.2$) are reproduced. The color temperature can also be set to 9300K, 6500K or 5600K, and manual white balance lets you directly adjust gain and bias for R, G and B.

Calibration Function

The BT-LH910G comes installed with software that allows it to be calibrated without using a PC, by simply connecting a manufacturer-designated display color analyzer and measurement probe to the monitor.

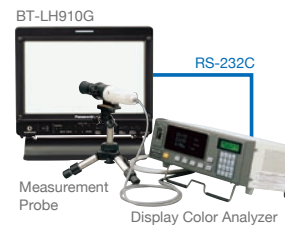

*Konica Minolta CA-310 Display Color Analyzer with CA-PU32/PU35 or CA-PSU32/PSU35 Standard Measurement Probe. For more information about the Konica Minolta calibration system, please see the following website.
<<http://www.konicaminolta.com/instruments/index.html>>.



Front Panel



Rear Panel

Diverse 3D Camera Assist Functions

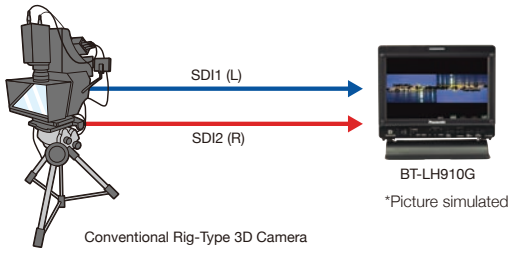

When the left-eye and right-eye video signals from a 3D camera are connected to the two SDI input terminals, the BT-LH910G lets you check 3D images on its 2D display. The BT-LH910G is also provided with a variety of functions to help adjust a rig-type 3D camera system. It helps to reduce preparation time for 3D shooting and boosts image accuracy.

3D Assist Functions Supported by Various Formats

1080/60i, 1080/59.94i, 1080/50i, 1080/25PsF, 1080/24PsF, 1080/23.98PsF, 1035/60i, 1035/59.94i, 720/60p, 720/59.94p, 720/50p

- **MIRROR:** The Mirror function simplifies the basic adjustments of a rig-type 3D camera system. With the left-eye and right-eye images displayed side-by-side on the screen, the right-eye image can be flipped in the horizontal or vertical direction.

- **SHIFT:** This function lets you move only the right-eye image horizontally or vertically in the overlay display. It's handy for checking angle misalignment between the left-eye and right-eye images.



- **COMPARISON:**

The Comparison function displays half-tone markers inside the left-eye and right-eye images displayed side-by-side. It lets you confirm that there are no missing image segments at the frame edge of only one image.



- **CONVERGENCE:** With the left-eye or right-eye image displayed on the full screen, the Convergence function lets you switch the images automatically or manually. This makes it easier to confirm the convergence point.

- **COLOR:** The Color function combines left-eye and right-eye images and displays them in a checkerboard pattern on a full screen. It allows you to check the brightness and color variance between the two images.



- **ZOOM FOCUS:** This function enlarges and displays a section of images displayed side-by-side. It can be used to check the variance in focus and zoom between the left-eye and right-eye images. Focus-in-Red can also be used together with this function.

- **VERTICAL:** The Vertical function lets you closely inspect vertical misalignment between the left-eye and right-eye images using an auxiliary horizontal-line marker.



- **OVERLAY:** Using this function, you can check the width of the left-right disparity by superimposing a vertical-line marker (in 3% intervals) on the overlay display or difference image between right and left in black-and-white display.



*The Overlay display on the BT-LH910G does not provide 3D effects even if 3D Eyewear is worn.

System Connection with Camera Recorders

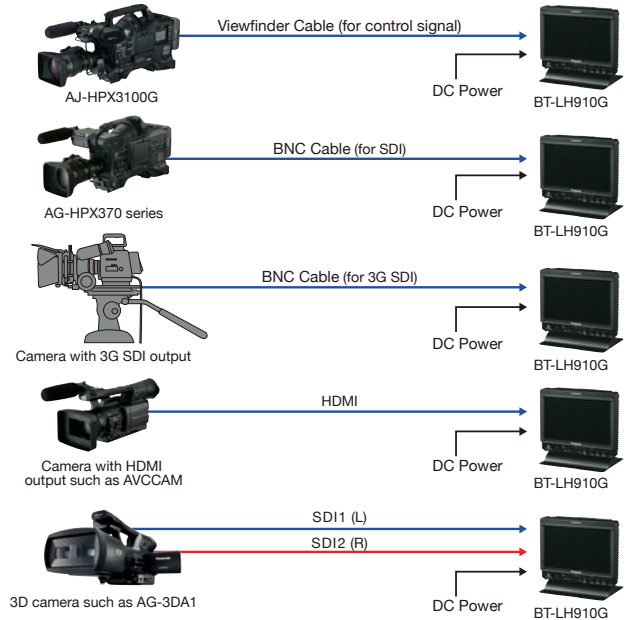

Signal Format for BT-LH910G

Input Signal	VIDEO	VF-VIDEO	VF-YPbPr	YPbPr	SDI1 (3G SDI)	SDI2	HDMI
NTSC	✓	✓					
PAL	✓	✓					
640 x 480 (59.94Hz)							✓
640 x 480 (60Hz)							✓
480/59.94i			✓	✓	✓	✓	✓
480/59.94p			✓	✓	✓	✓	✓
576/50i			✓	✓	✓	✓	✓
576/50p			✓	✓			✓
720/50p			✓	✓	✓	✓	✓
720/59.94p			✓	✓	✓	✓	✓
720/60p			✓	✓	✓	✓	✓
1035/59.94i*1			✓	✓	✓	✓	✓
1035/60i*2			✓	✓	✓	✓	✓
1080/23.98PsF			✓	✓	✓	✓	✓
1080/24PsF			✓	✓	✓	✓	✓
1080/25PsF*3			✓	✓	✓	✓	✓
1080/50i			✓	✓	✓	✓	✓
1080/59.94i			✓	✓	✓	✓	✓
1080/60i			✓	✓	✓	✓	✓
1080/23.98p					✓	✓	✓
1080/24p					✓	✓	✓
1080/25p					✓	✓	✓
1080/29.97p					✓	✓	✓
1080/30p					✓	✓	✓
1080/50p					✓ ^{*2}	✓	✓
1080/59.94p					✓ ^{*2}	✓	✓
1080/60p					✓ ^{*2}	✓	✓

✓: Supported *1: Displayed as 1080/59.94i when input is 1035/59.94i. *2: Displayed as 1080/60i when input is 1035/60i. *3: Displayed as 1080/50i when input is 1080/25PsF. *4: RGB444 and SDI422 (12 bit) are not supported.

Option

As of March, 2011



BT-CS910G
VF Cable

Outstanding Display Performance, Extensive Recording Assist Functions and a Wealth of Interfaces for Broadcasting Use.

Cine-gamma and New Black Mode

The BT-LH910G is equipped with a cine-gamma (F-REC) compensation function and serves as a monitor for the Varicam camera recorder. The new black mode also makes dark image areas in low-gradation scenes easier to see. It helps to produce movies as well as film-like HD programs and commercial.

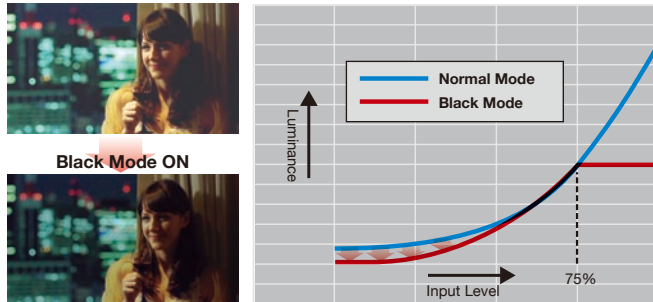

*Pictures simulated.

New Audio Level Meter and Headphone Terminal

The new color audio level meter displays the embedded audio (3G-SDI, SDI, HDMI*) input level. And it's equipped with reference point setting, peak hold and over-range display functions. The BT-LH910G is also provided with a headphone terminal. The channel to be monitored is easily selected from the menu.



*For HDMI input, the level meter displays only two channels.

WFM (Y/R/G/B) and Vector Scope Display

The BT-LH910G has built-in waveform monitor and vector scope functions to display the input signal waveform and color gamut. For waveform display, the signal can be selected from Y, R, G and B.



*The WFM function can be used for all input signals. The vector scope function can be used for 3G-SDI and SDI input.

Focus Assist Functions for HD Shooting

- **Focus-in-Red:** Emphasizes the sharply focused area of the image by showing it in an easily visible red.
- **Pixel-to-Pixel:** Displays video pixels without any resizing. With 1080i/p input signals, you can check the focus with a screen width equivalent to 34.3 cm (13.5 inches).



Focus-in-Red ON

Closed Caption and Time Code Display

The BT-LH910G can display closed captions with an SDI or VIDEO input. It supports the EIA-708 HD-SDI closed captioning standard (EIA-608 SD-SDI closed captioning standard), and can display up to eight windows simultaneously. The BT-LH910G can also display the time code (selectable from VITC, LTC and UB) with an SDI input.



Various Markers

Various markers can be displayed in both 16:9 and 4:3 aspect ratios.

- **Aspect Marker (16:9):** 4:3, 13:9, 14:9, CNSCO2.39, CNSCO2.35, 2:1 or VISTA, with background brightness control of Black (0%), Half (50%) or Normal (100%).
- **Safe Area Marker (16:9/4:3):** 95%, 93%, 90%, 88% or 80%.
- **Center Marker (16:9/4:3):** ON/OFF. The center marker can be displayed together with another marker, as shown in the example above. In 16:9 mode, the BT-LH910G can display a superimposed safe area marker corresponding to the aspect marker which is selected.



Safe Area /Center Marker

A Diversity of Display Functions

- **Cross Hatch Overlay:** Displays grids with 40 or 80 pixel intervals. This is useful for horizontal/vertical adjustment.
- **HV Delay Display:** Displays the video blanking period.
- **Mono Mode:** Displays images in black-and-white.
- **Split Screens:** A frame of video can easily be frozen and displayed as a still image on the left side of the screen. This function can be used to match a live camera with a frame of video shot at an earlier time or with a different camera.



Three Function Keys

Each of the function keys can be assigned with a function selected from various display and switchover functions to enable one-touch ON/OFF or mode change.

Functions Assignable to Function Keys

- HV Delay/Blue Only/Gamma Select/SD Aspect/Scan/Sub Window/WFM/Vector/Marker/White Balance/Pixel To Pixel/Pixel Position/Focus-In-Red/Zebra/Rear Tally/Level Meter/Cross Hatch/Mono/Black Mode/Time Code/Closed Caption/Undef

Versatile Input Terminals, Including 3G-SDI and HDMI

The BT-LH910G is equipped with input terminals for 3G-SDI, SDI (HD and SD), HDMI, composite (Video) and component (Y/PbPr) signals. It supports almost all HD/SD video signals for use in various applications worldwide.

Viewfinder Connector

Equipped with a 15-pin viewfinder terminal, the BT-LH910G can also be used as a viewfinder for compatible Panasonic camera recorders* (requiring the optional BT-CS910G VF Cable).

*AJ-HPX3700, AJ-HPX2700, AJ-HPX3100, AJ-HPX2000, AJ-HPX2100, AJ-HDX900, AG-HPX500 series (AG-HPX500 series displays SD resolution in black-and-white.). Optional hardware is required for mounting to a camera recorder.

Designed for Broadcast Field Work

- Tilt stand and headphone terminal.
- The front and rear tally lamps are also functional when the monitor is used as a camera viewfinder.
- SERIAL (9-pin) and GPI (9-pin) remote input terminals.
- The slim, lightweight, compact body allows flexible installation and setup.
- Robust, durable magnesium diecast frame.
- DC drive. Anton Bauer battery can be mounted to the back.

[General]

Power Requirement:	DC 12 V (11.0 V – 17.0 V), 1.9 A
Dimensions (W x H x D):	230 mm x 214.5 mm x 170 mm, including stand (9-1/16 inches x 8-7/16 inches x 7-11/16 inches) 230 mm x 183 mm x 78.5 mm, not including stand (9-1/16 inches x 7-13/64 inches x 3-1/16 inches)
Weight:	2.4 kg (5.3 lbs), including stand 1.7 kg (3.7 lbs), not including stand
Operating Temperature:	0 °C to 40 °C (32 °F to 104 °F)
Operating Humidity:	10 % to 85 % (no condensation)
Storage Temperature:	-20 °C to 60 °C (-4 °F to 140 °F)

[LCD Panel]

Panel Size:	23 cm (9 inches) of effective display area
Aspect Ratio:	15:9
Resolution:	1280 x 768 (WXGA)
Display Colors:	Approx. 16,770,000 colors
Viewing Angle:	176° both of horizontal and vertical

[Connectors]

Video Input:	Video: BNC x 1 Y/Pb/Pr: BNC x 3 (Y shares with Video) HDMI: HDMI (type A) x 1 (HDCP supported, embedded audio supported, VIERA Link not supported) SDI: BNC x 2 (active through connector x 2) SMPTE274M/296M/259M-C/ ITU-R BT.656-4 compliant Embedded Audio HD-SDI: SMPTE299M compliant Embedded Audio SD-SDI: SMPTE272M compliant VF: D-SUB, 15 pins x 1
Headphone Output:	M3 stereo mini jack x 1
Remote:	GPI: D-SUB, 9 pin x 1 SERIAL: D-SUB, 9 pin x 1
External DC Power Input:	XLR, 4 pin

[Others]

Supplied Accessories:	Tilt stand (built-in), Tilt stand mounting screws (built-in), CD-ROM
Option:	BT-CS910G VF Cable

Dimensions

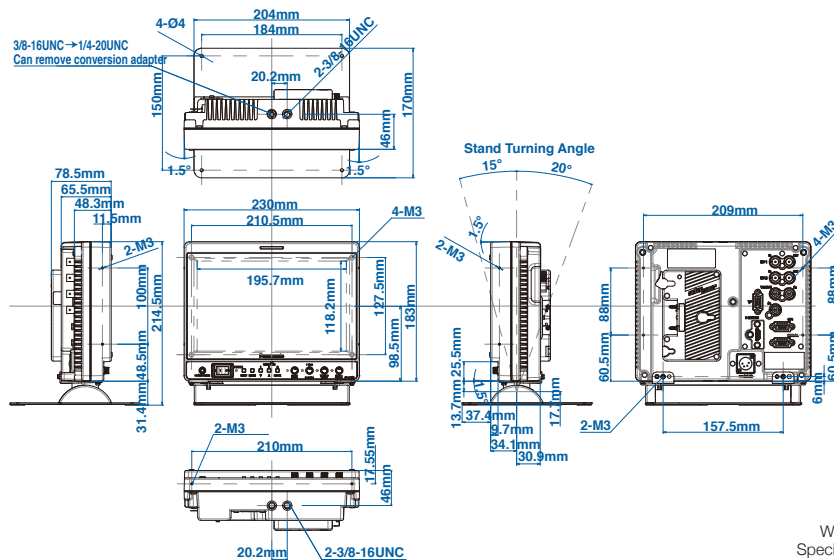

Weight and dimensions shown are approximate. Specifications are subject to change without notice.

Please refer to the latest Broadcast and Professional AV Product Information on the Panasonic website.



<http://pro-av.panasonic.net/>

Panasonic®

[Countries and Regions]

Panasonic Corporation
Digital Imaging Business Group
 2-15 Matsuba-cho, Kadoma, Osaka 571-8503
 Japan
<http://pro-av.panasonic.net/>

Argentina	+54 1 308 1610
Australia	+61 2 9986 7400
Bahrain	+973 252292
Belgium	+32 (0) 2 481 04 57
Brazil	+55 11 3889 4035
Canada	+1 905 624 5010
China	+86 10 6515 8828
Hong Kong	+852 2313 0888
Czech Republic	+420 236 032 552/511
Denmark	+45 43 20 08 57
Egypt	+20 2 23938151
Finland, Latvia, Lithuania, Estonia	+358 (9) 521 52 53
France	+33 (0) 1 55 93 66 67
Germany, Austria	+49 (0)611 235 0
Greece	+30 210 96 92 300
Hungary	+36 (1) 382 60 60
India	+91 120 247 1000
Indonesia	+62 21 385 9449
Iran (Vida)	+98 21 2271463
(Panasonic Office)	+98 2188791102
Italy	+39 02 6788 367
Jordan	+962 6 5859801
Kazakhstan	+7 727 298 0891
Korea	+82 2 2106 6641
Kuwait	+96 522431385

Lebanon	+96 11665557
Malaysia	+60 3 7809 7888
Mexico	+52 55 5488 1000
Netherlands	+31 73 64 02 577
New Zealand	+64 9 272 0100
Norway	+47 67 91 78 70
Pakistan	+92 5370320 (SNT)
Palestine	+972 2 2988750
Panama	+507 229 2955
Peru	+51 1 614 0000
Philippines	+63 2 633 6163
Poland	+48 (22) 338 1100
Portugal	+351 21 425 77 04
Puerto Rico	+1 787 750 4300
Romania	+40 21 211 4855
Russia & CIS	+7 495 6654205
Saudi Arabia	+96 626444072
Singapore	+65 6270 0110
Slovak Republic	+421 (0) 2 52 92 14 23
Slovenia, Albania, Bulgaria, Serbia, Croatia, Bosnia, Macedonia, Montenegro	+36 (1) 382 60 60
South Africa	+27 11 3131622
Spain	+34 (93) 425 93 00
Sweden	+46 (8) 680 26 41
Switzerland	+41 (0) 41 259 96 32
Syria	+963 11 2318422/4

Taiwan	+886 2 2227 6214
Thailand	+66 2 731 8888
Turkey	+90 216 578 3700
U.A.E. (for All Middle East)	+971 4 8862142
	+380 44 4903437
Ukraine	+44(0)1344 70 69 13
U.K.	+1 877 803 8492
U.S.A.	+848 38370280
Vietnam	



JQA-0443



Factories of Systems Business Group have received ISO14001:2004-the Environmental Management System certification. (Except for 3rd party's peripherals.)